

1/18

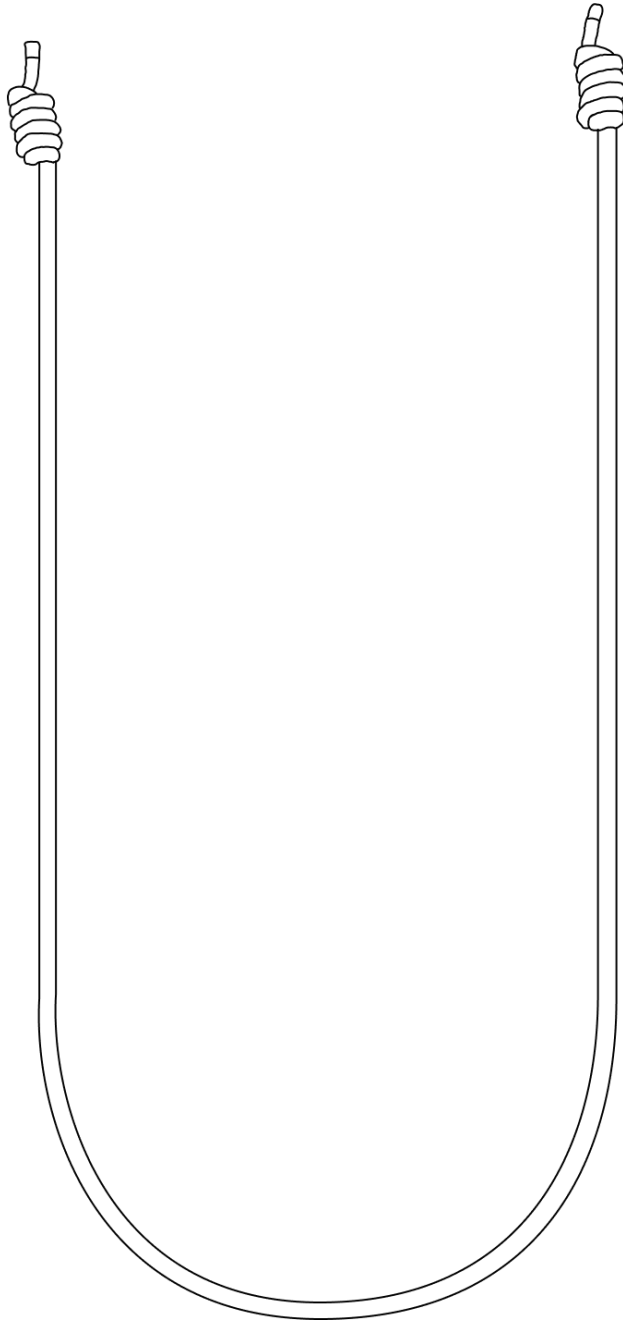

FIG. 1  
(Prior Art)

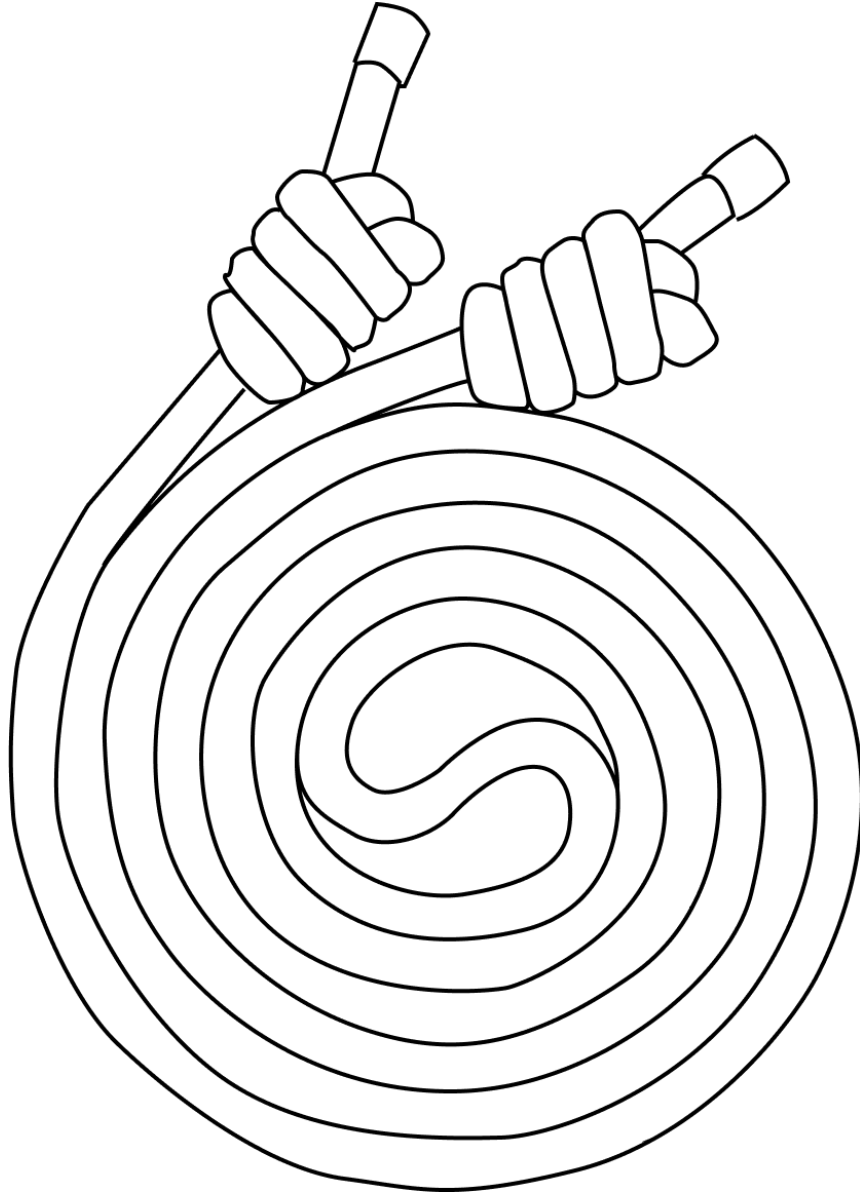

FIG. 2  
(Prior Art)

3/18

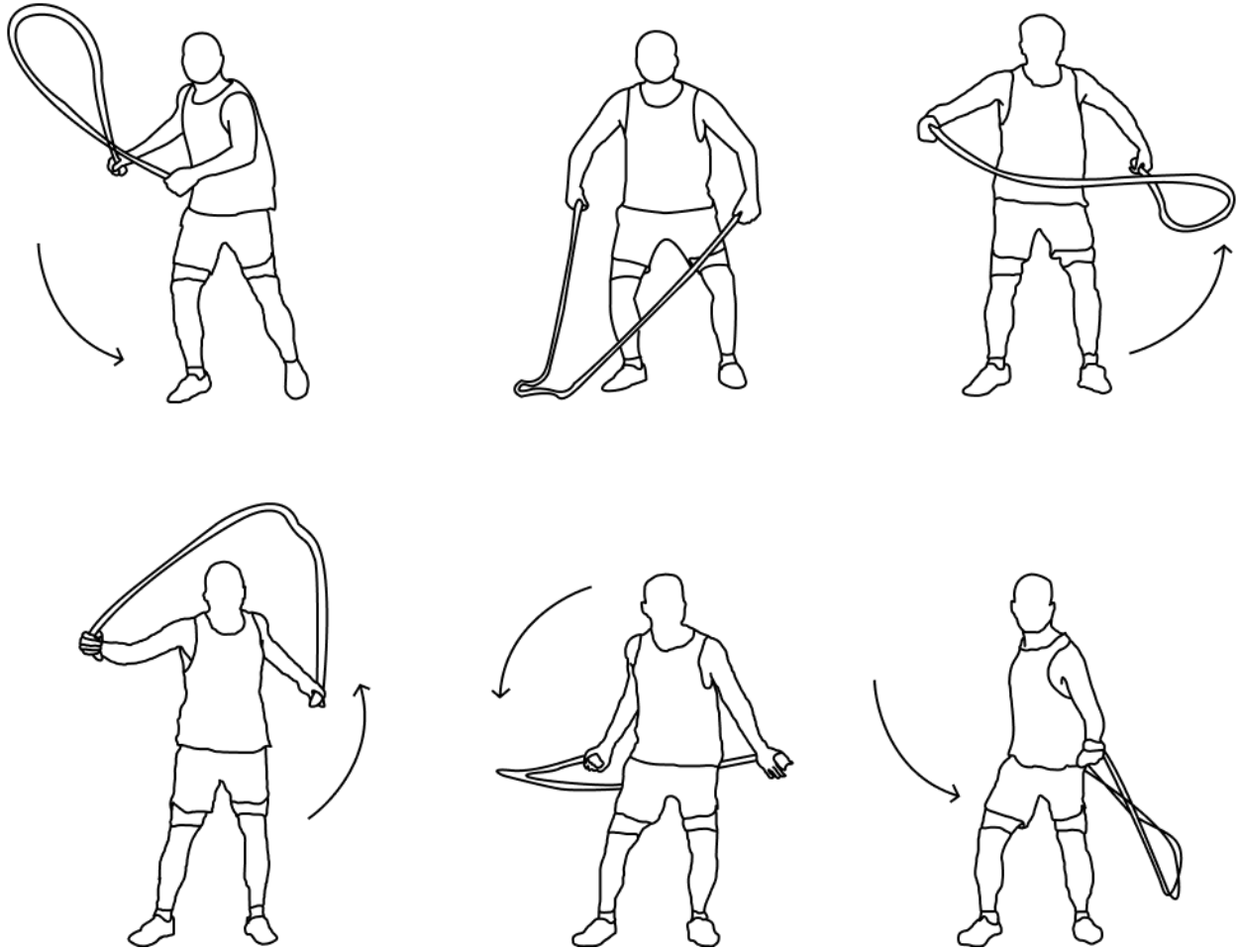

FIG. 3  
(Prior Art)

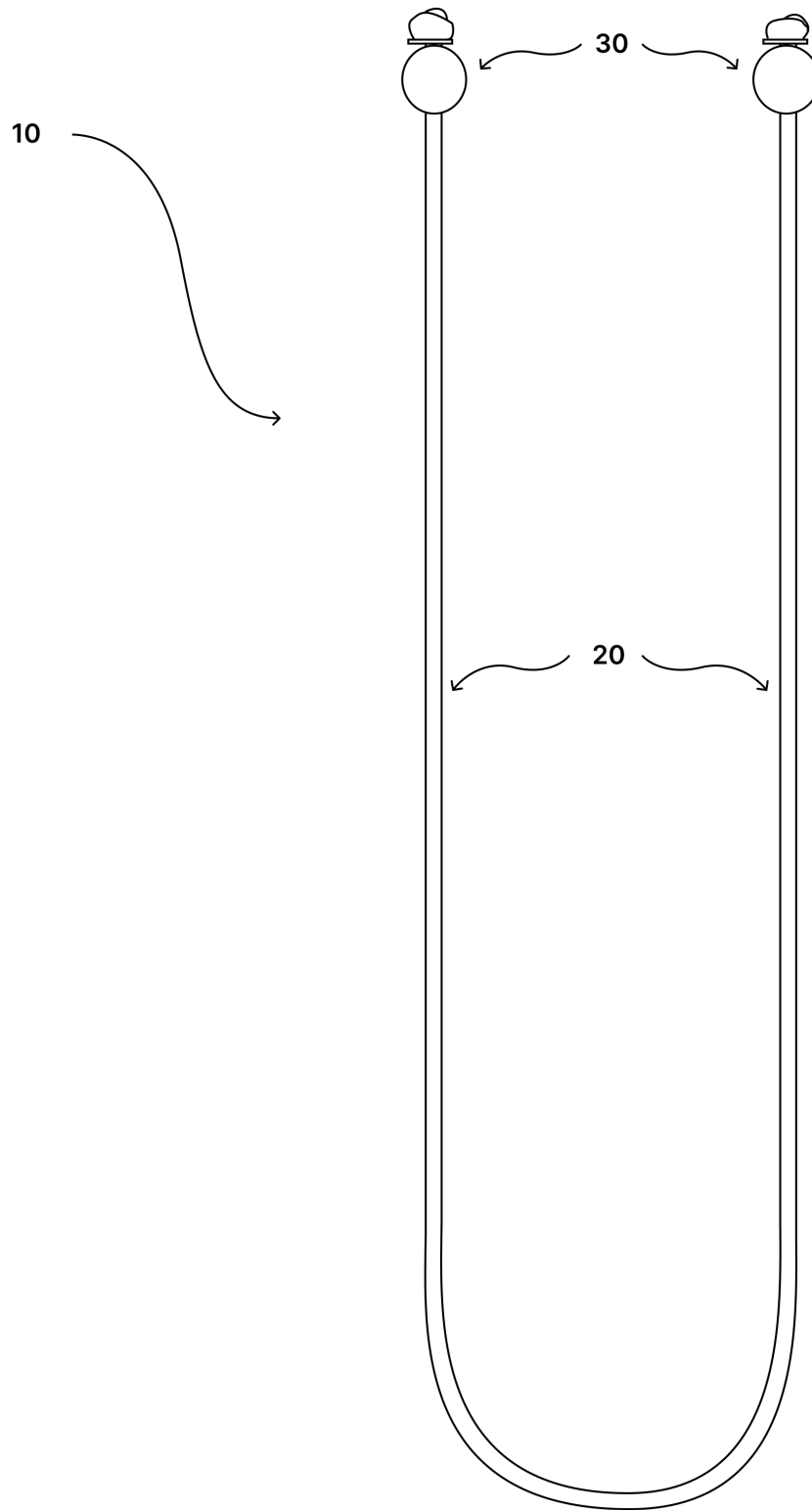

FIG. 4

5/18

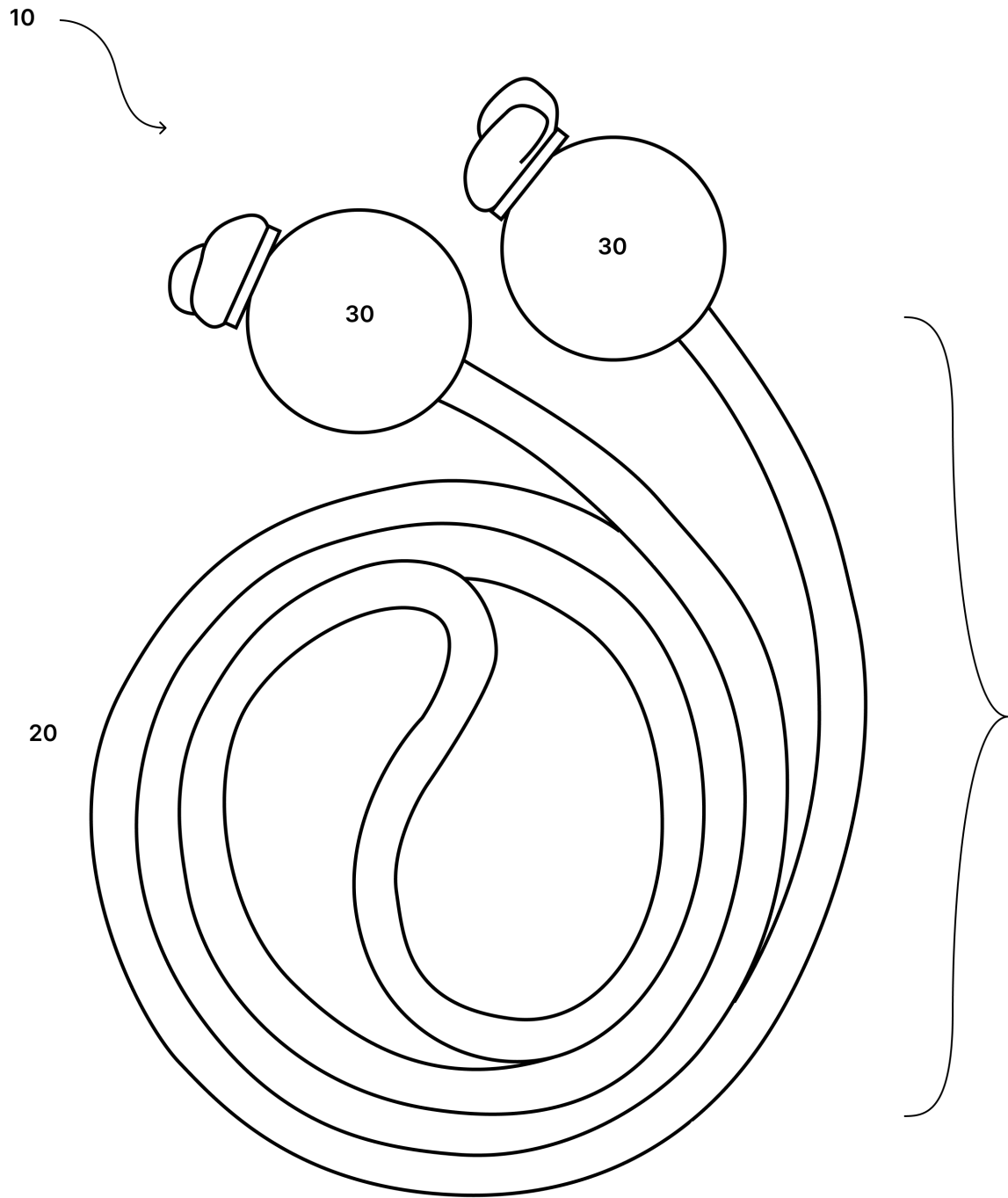

FIG. 5

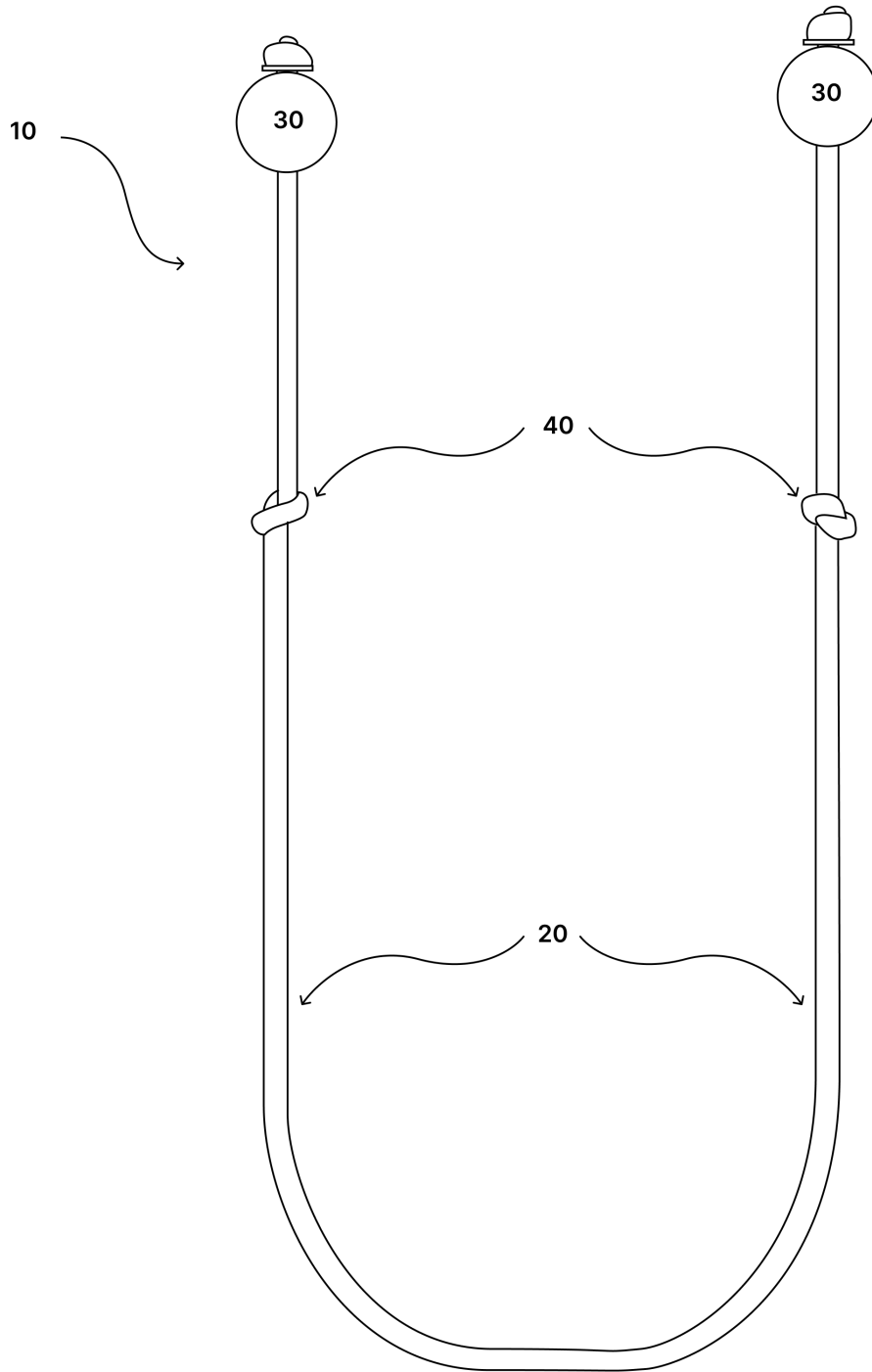

FIG. 6

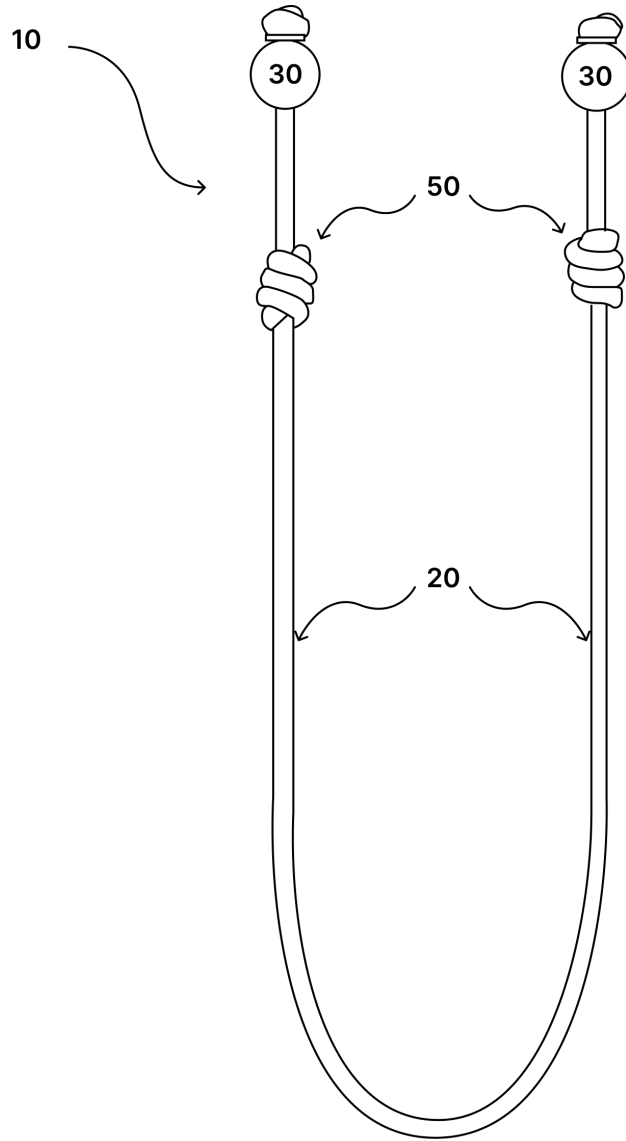

FIG. 7

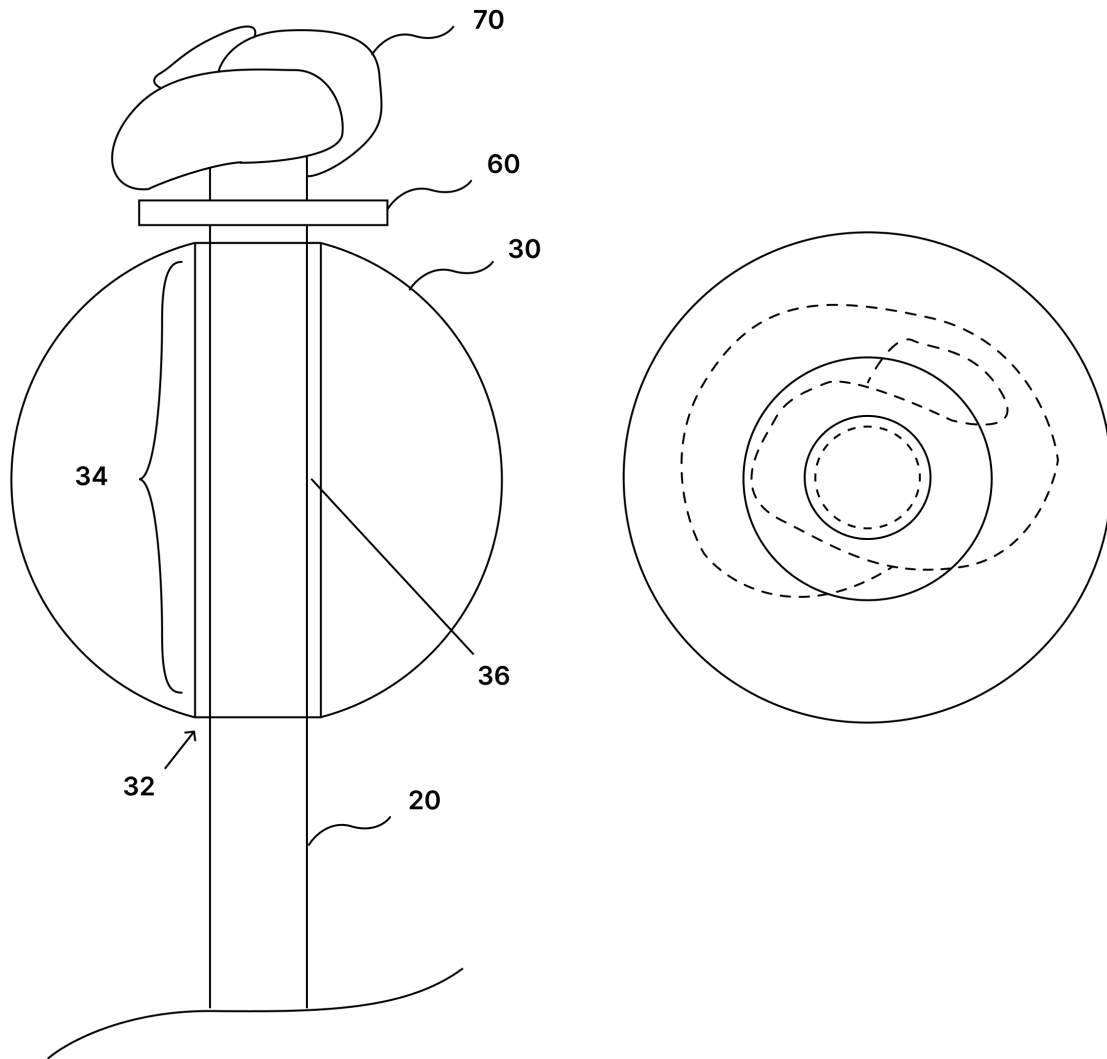

FIG. 8



9/18

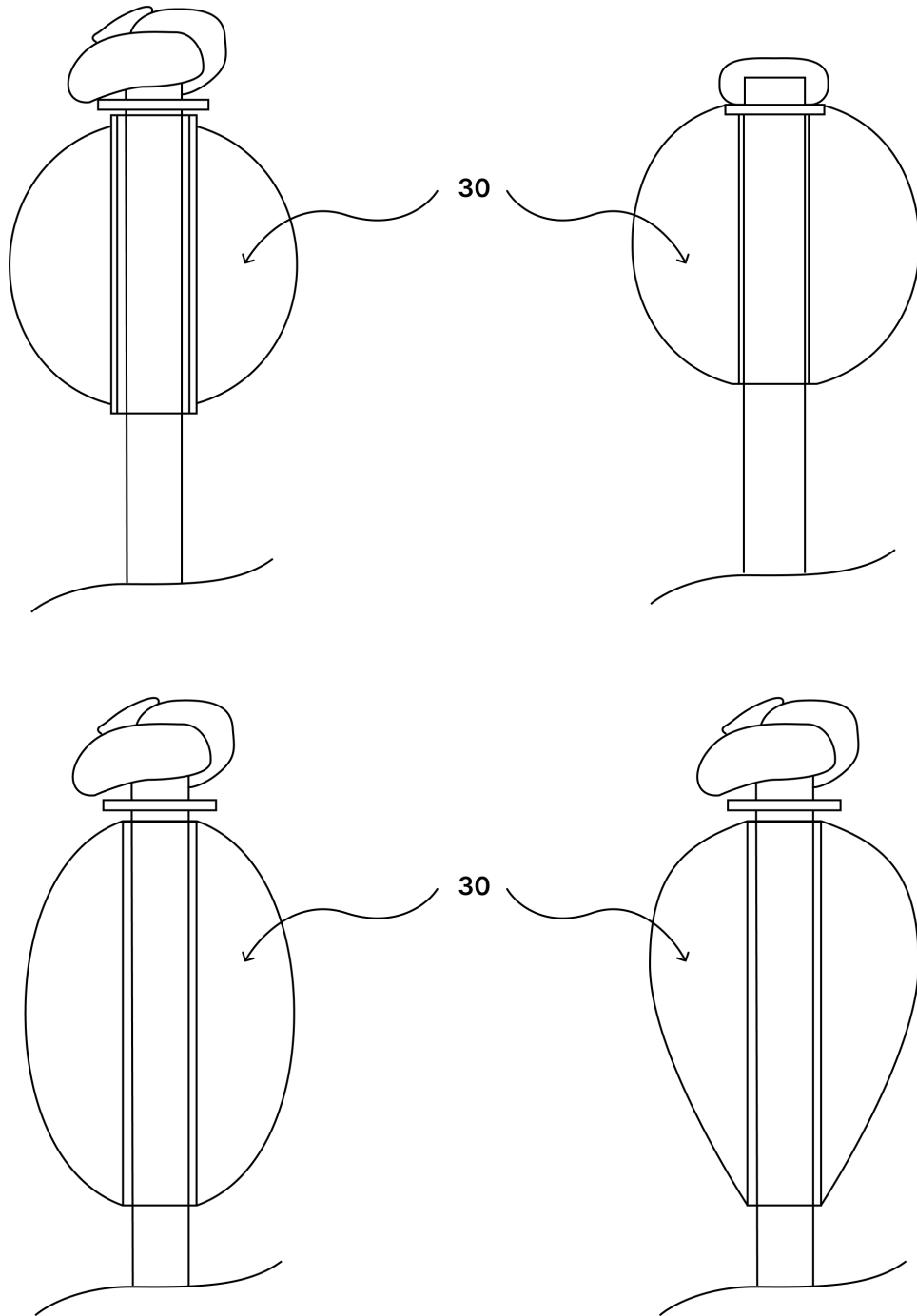

FIG. 9

10/18

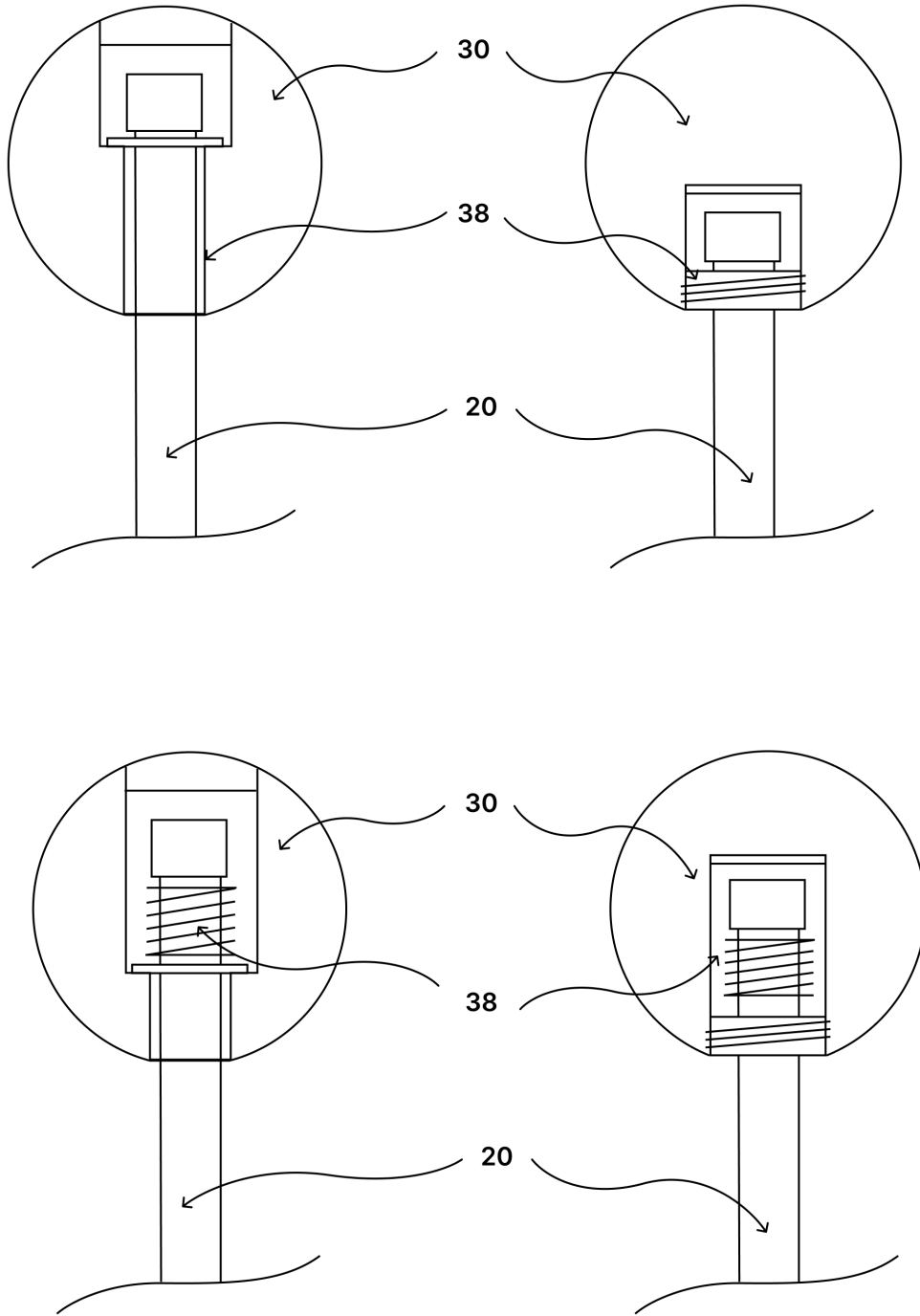

FIG. 10

11/18

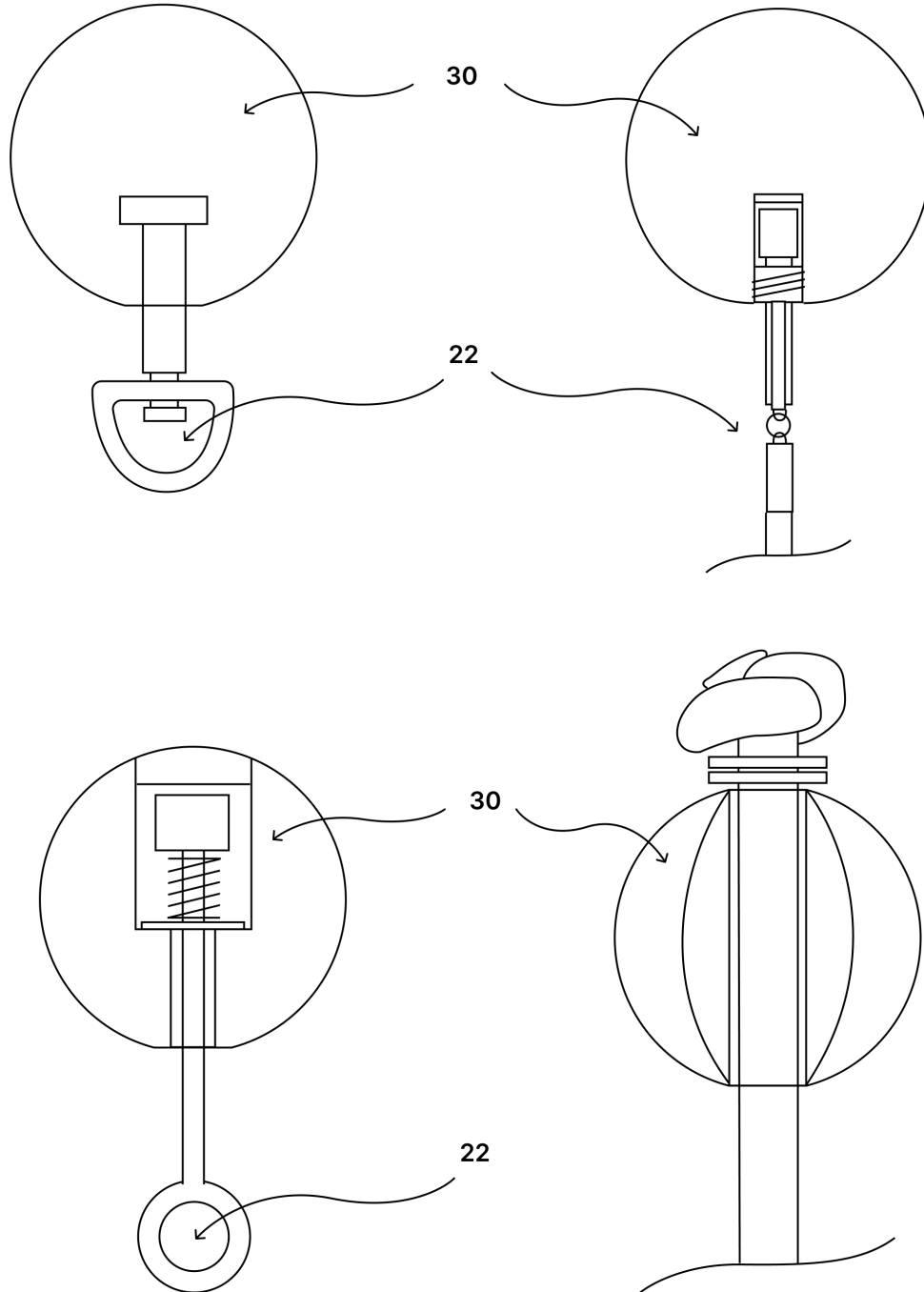

FIG. 11

12/18

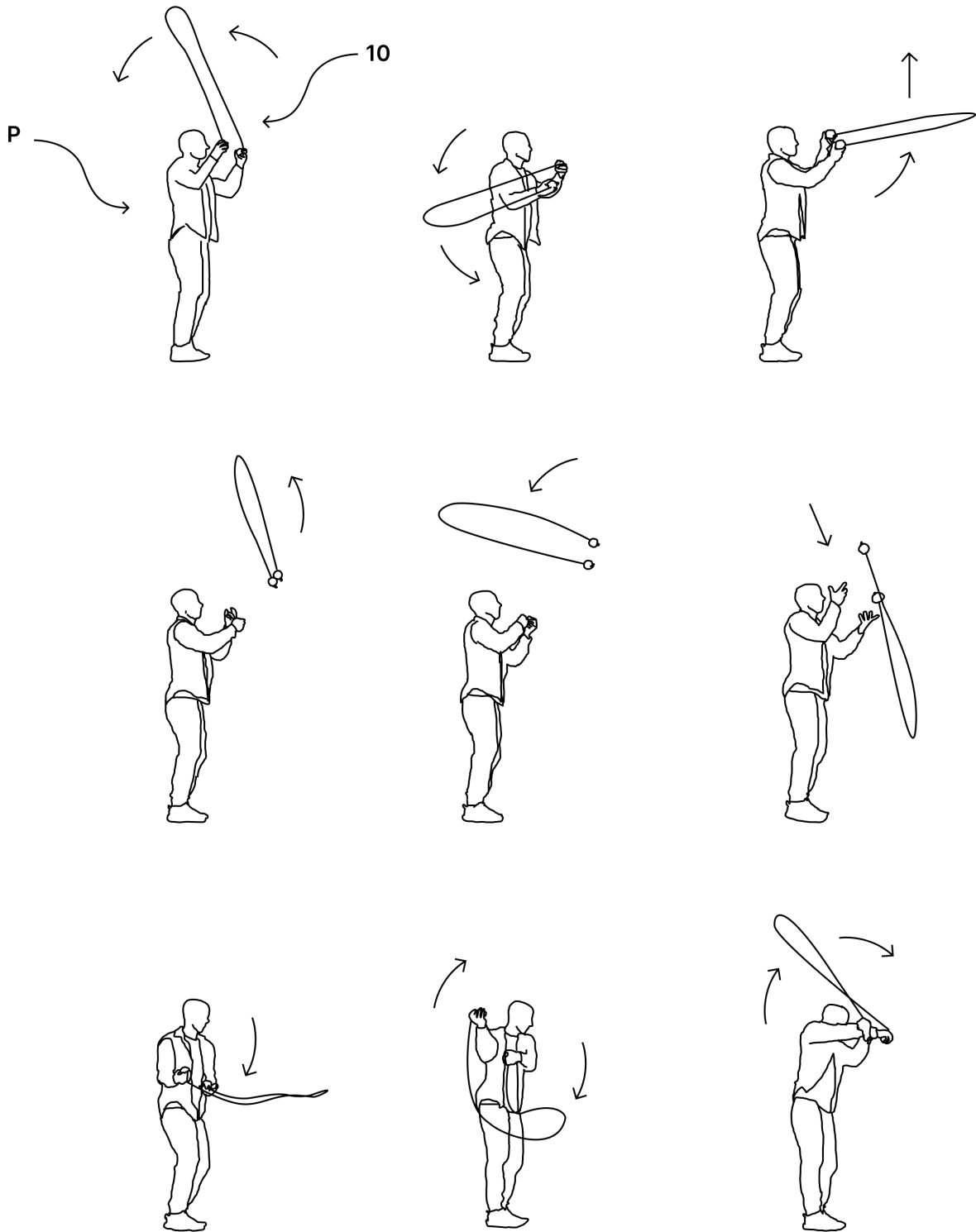

FIG. 12

13/18

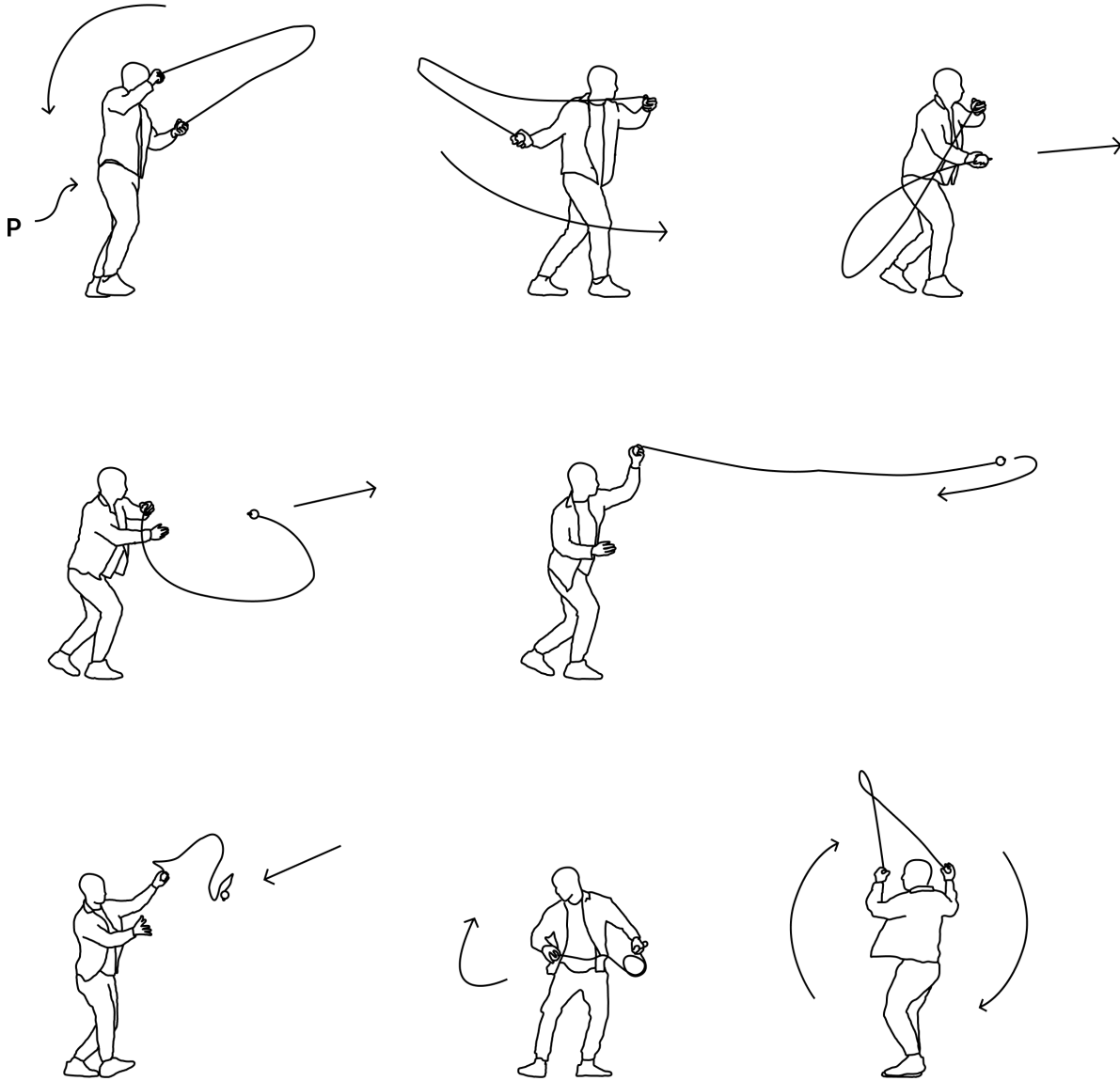

FIG. 13

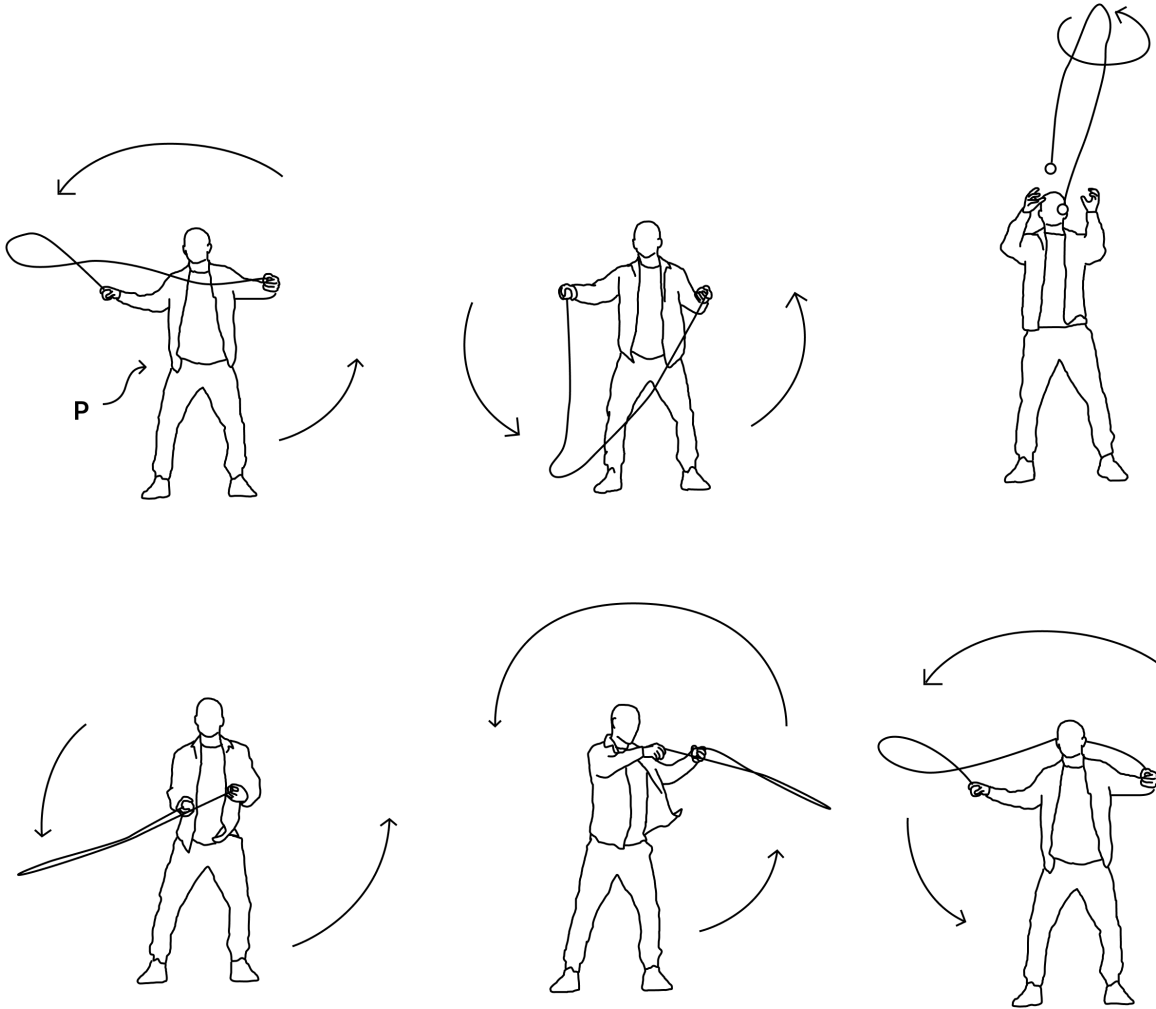

FIG. 14

15/18

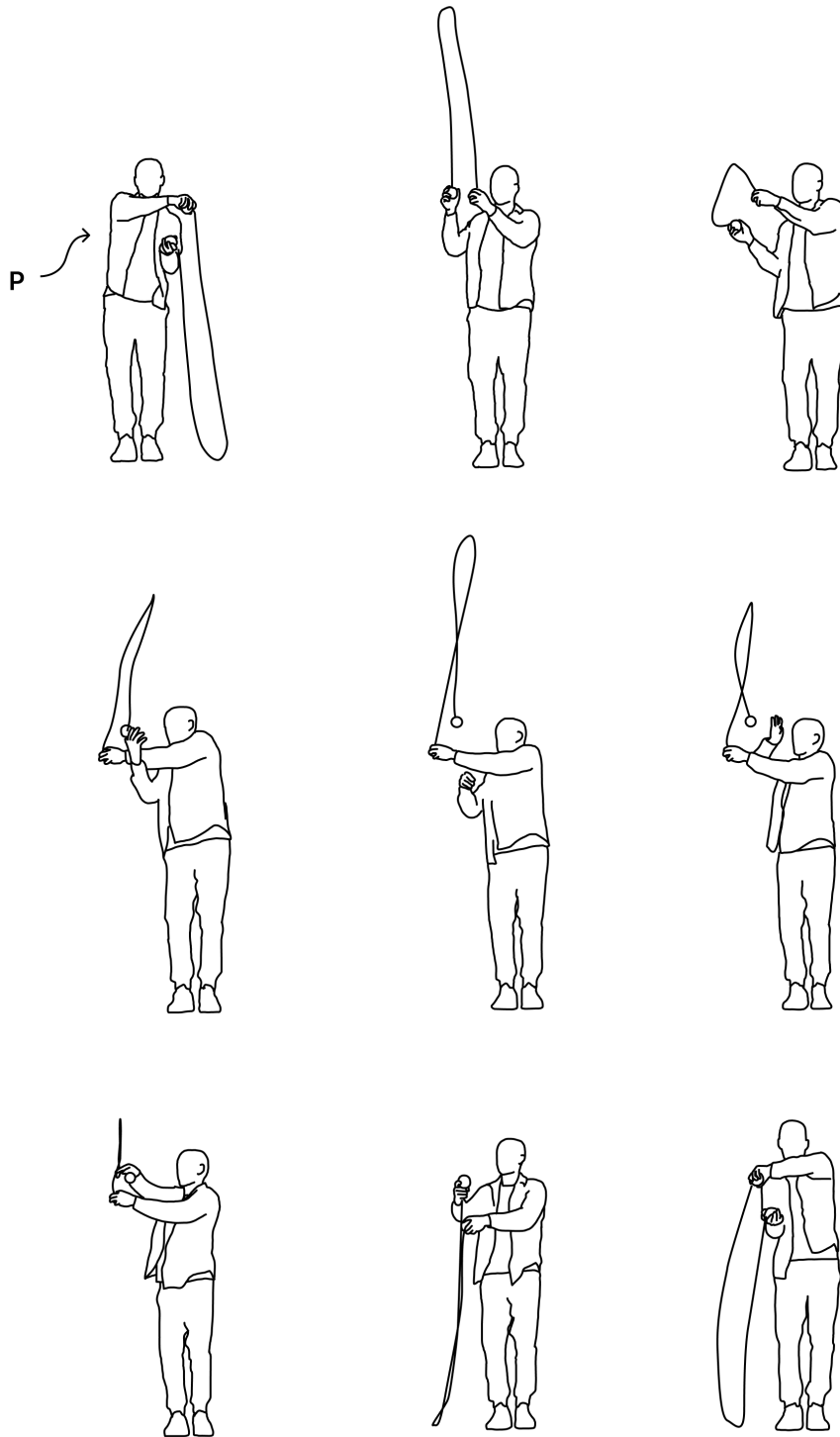

FIG. 15

16/18

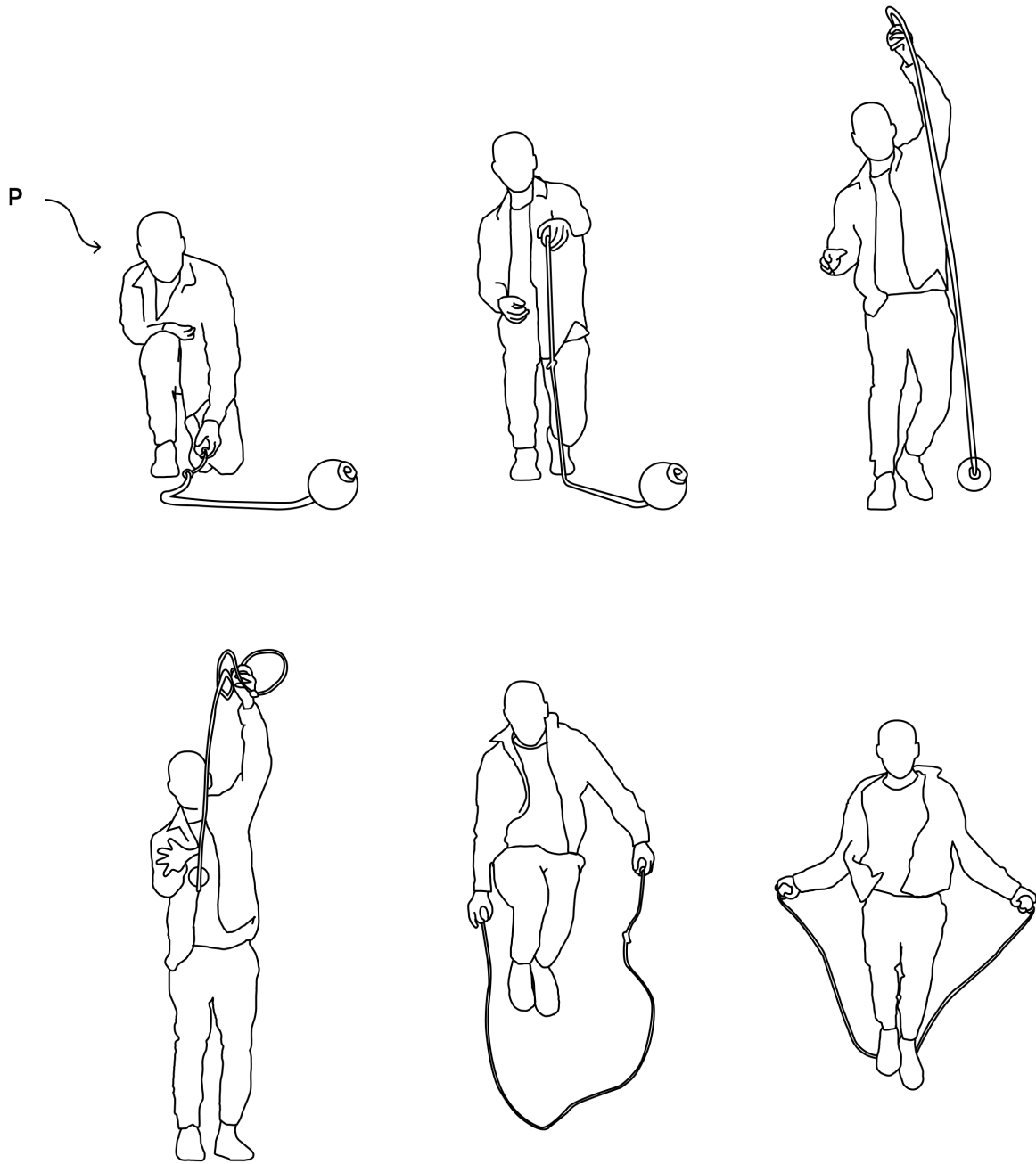

FIG. 16



17/18

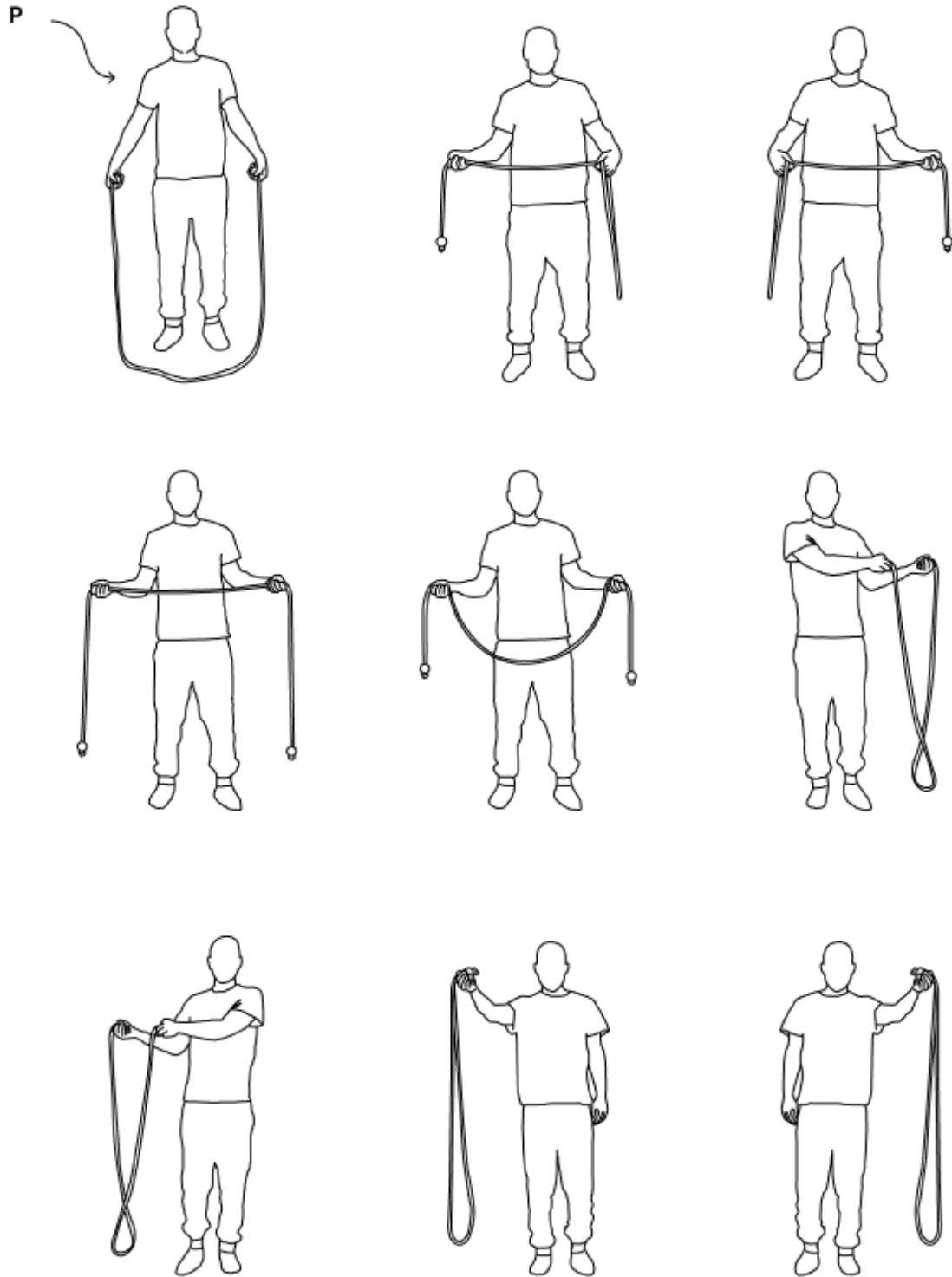

FIG. 17

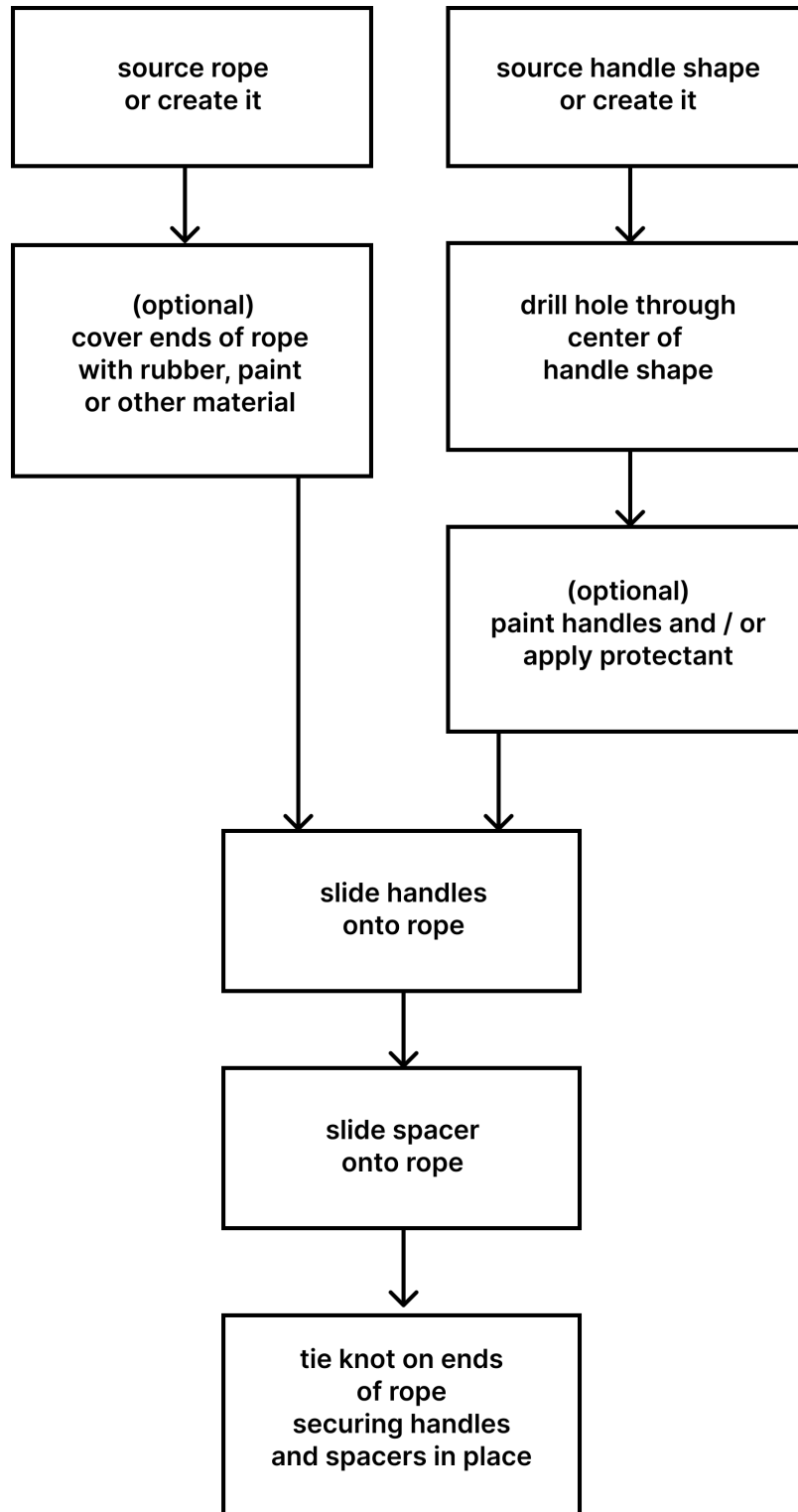

FIG. 18